

**Bedienblende / Control panel**

Spannung / Voltage: **3 N AC 400V 50Hz**

Baugruppe / Group: **1** Ausgabe / Edition: **1.1.1**

Gültig ab Seriennummer / Applicable from serial. no.: **E12DA97061001**

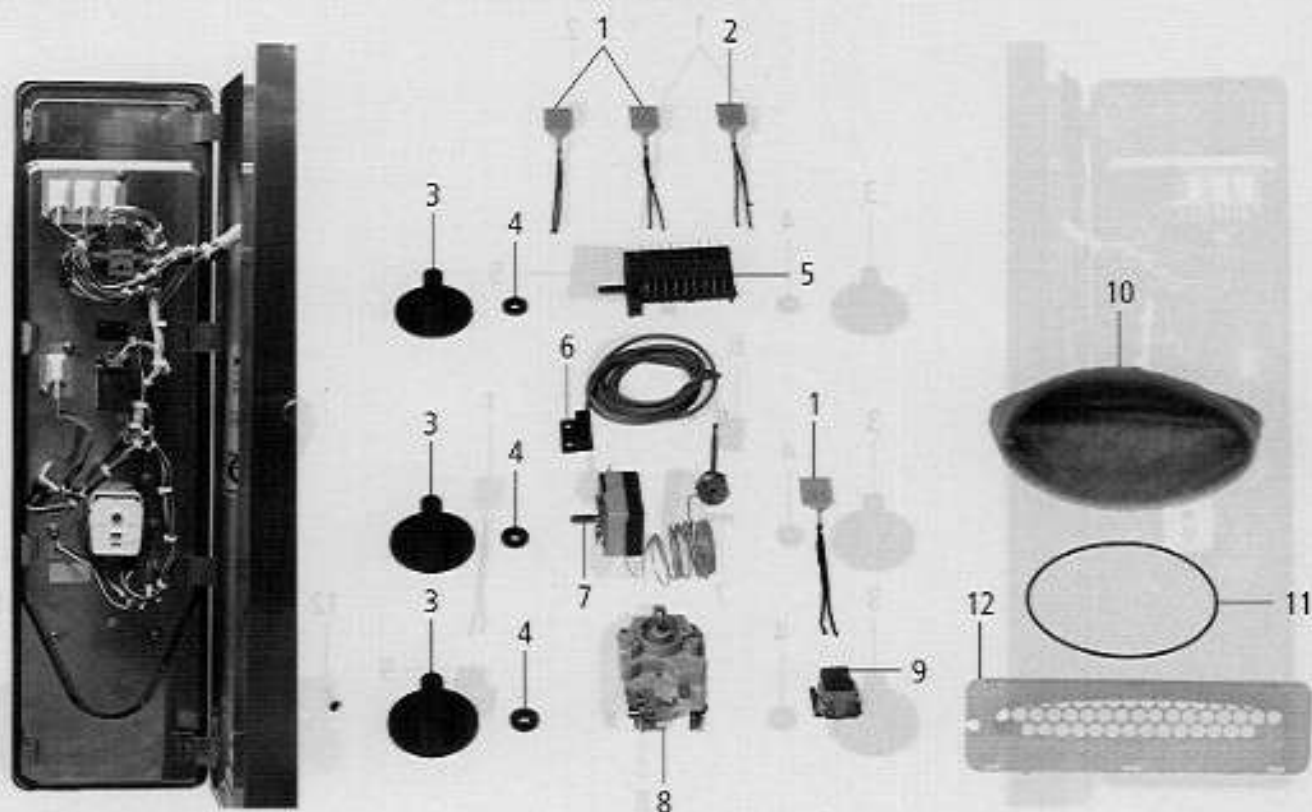

Pos.	St.	Ersatzteil Nr.	Bezeichnung	Description	Bez. Sign.
Pos.	Pcs.	Spare part no.			
1	3	3024.0310	Signallampe rot	Control lamp red	H2,4,5
2	1	3024.0309	Signallampe grün	Control lamp green	H3
3	3	3013.0344	Knebel	Dial	
4	3	5110.1027	Distanzscheibe	Distance plate	
5	1	3016.1613	Betriebsartenschalter	Mode switch block	S1
6	1	3016.1415	Türkontaktschalter	Door contact switch	
-	2	1103.0600	Spreizmutter 2mm	Expansion nut 2mm	
-	2	1304.0150	Unterlegscheibe A3,2	Washer A3,2	
-	2	1003.2160	Sechskant Blechschraube A2,9x9,5	Hex self-tapping screw A2,9x9,5	
7	1	3014.0166	Thermostat Heißluft	Thermostat hot air/ unit too hot	P1
8	1	3013.0104	Zeitschaltuhr 120min. 50Hz	Timer 120 min. 50Hz	S2
9	1	3006.0101	Alarmsummer	Alarm buzzer	T2
10	1	5214.1300	Luftfilter Bedienblende	Air inlet filter control panel	
11	1	5012.0565	O-Ring Luftfiltereinsatz	O-Ring air inlet filter control panel	
12	1	2039.0337	Filterträger Bedienblende	Filter support control panel	

**Gerätetür / Door**

Spannung / Voltage: **3 N AC 400V 50Hz**

Baugruppe / Group: **8** Ausgabe / Edition: **8.1.1**

Gültig ab Seriennummer / Applicable from serial. no.: **E12DA97061001**

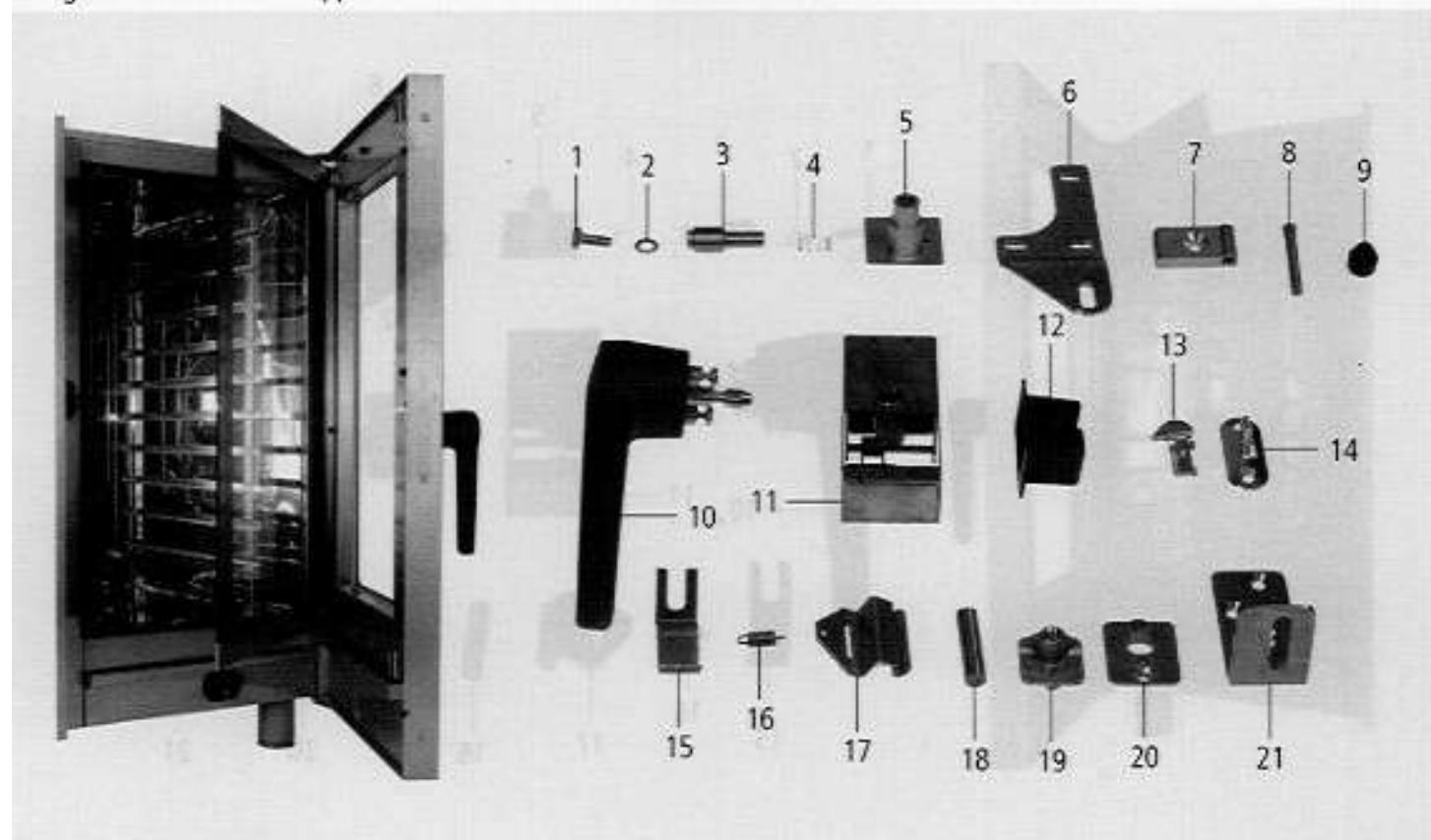

Pos.	St.	Ersatzteil Nr.	Bezeichnung	Description	Bez.
Pos.	Pcs.	Spare part no.			Sign.
-	1	8470.1302	Türe kpl.	Door cpl.	
-	1	8474.1338	Innenglasscheibe kpl.	Internal glass cpl.	
-	1	5105.1022	Garraumdichtung	Door gasket	
1	1	1006.0761	Sechskantschraube M 6x12	Hexagonal screw M 6x12	
2	1	1306.0120	Unterlegscheibe A6,4	Washer A6,4	
3	1	2120.1254	Achszapfen Tür oben	Door bolt top	
4	1	2001.0118	Druckfeder oberer Türhaltebolzen	Compression spring upper door bolt	
5	1	2940.1300	Achshülse Tür oben	Sleeve for door bolt	
6	1	2939.1307	Türhaltewinkel oben	Door holding angle top	
-	3	1008.0200	Linienkopfschraube mit Innensechskant	Raised countersunk allen screw M8x16	
7	1	2940.1309	Scharnier für Innenscheibe	Hinge for inner glass	
-	2	1005.1960	Senkschraube mit Innensechskant M5x16	Hex socket countersunk head screw M5x16	
8	1	2120.1258	Rändelbolzen für Türhaltescharnier	Knurdeled bolt for inner door hinge	
9	1	2039.0402	Puffer für Türe	Door buffer	
10	1	2016.1504	Türgriff	Door handle	
11	1	8474.1300	Verschluss kpl. für Tür	Lock for door handle cpl.	
12	1	2039.0319	Abdeckung f. Schloß Innenseite	Internal lock cover	
13	1	2940.1312	Kloben für Türe	Door catch	
-	1	1005.2000	Sperrzahnschraube M 5x8	Interlocking tooth screw M 5x8	
14	1	2940.1313	Klobenhalter für Türe	Base for door catch	
-	2	1006.0761	Sechskantschraube M 6x12	Hexagonal screw M 6x12	
15	1	2760.1396	Federhalter für Arretierung	Spring support for interior glass holding bracket	
16	1	2002.0106	Zugfeder für Arretierung Innenglasscheibe	Tension spring for inner window	
17	1	2760.1395	Arretierung Innenglasscheibe	Holding bracket for interior glass	
18	1	3016.1409	Magnet rund Tischgeräte	Magnet round table models	
19	1	2940.1302	Rasthülse	Door setting bolt	
-	1	1008.0766	Sechskantschraube M8x30	Hexagonal screw M8x30	
20	1	2940.1303	Rastzapfen 110°	Stop bolt 110°	
-	1	1005.1960	Senkschraube mit Innensechskant M5x16	Hex socket countersunk head screw M5x16	
21	1	2930.1306	Türhaltewinkel unten	Door mounting support bottom	
-	3	1006.1960	Senkschraube mit Innensechskant M6x16	Hexagonal socket countersunk head screw M6x16	

**Elektromontageplatte / Electrical Installation**

Spannung / Voltage: **3 N AC 400V 50Hz**

Baugruppe / Group: **3** Ausgabe / Edition: **3.1.1**

Gültig ab Seriennummer / Applicable from serial. no.: **E12DA97061001**

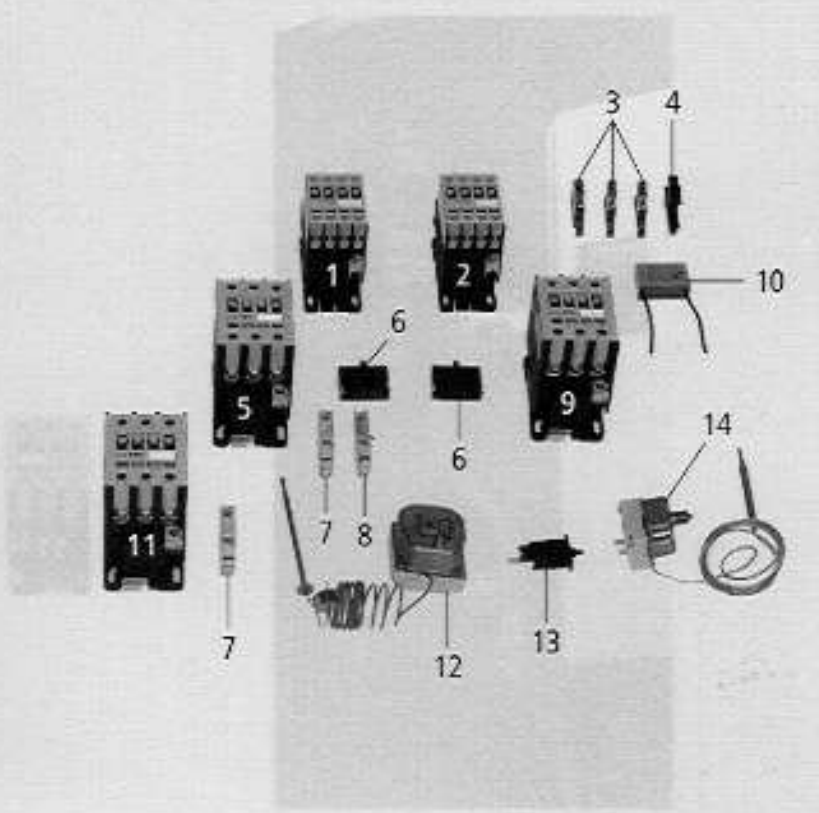

Pos.	St.	Ersatzteil Nr.	Bezeichnung	Description	Bez. Sign.
Pos.	Pcs.	Spare part no.			
1	1	3028.0550	Schütz AEG LS 4K01	Contacteur AEG LS 4K01	K2
2	1	3028.0550	Schütz AEG LS 4K01	Contacteur AEG LS 4K01	K2.1
3	3	4001.1216	Reihen клемме 4mm <sup>2</sup> grau	Terminal 4mm <sup>2</sup> grey	
4	1	4001.1203	Endklammer für Tragschiene	End plate for supporting rail	
5	1	3028.0554	Schütz AEG LS 15K00	Contacteur AEG LS 15K00	K3
6	1	3028.0562	RC-Glied für LS4K - LS30K	RC-link for LS4K - LS30K	C2
7	1	3028.0560	Hilfskontaktschalter HS07K10 N/C	Auxiliary contact switch HS07K10 N/C	
8	2	3028.0561	Hilfskontaktschalter HS07K01 N/O	Auxiliary contact switch HS07K01 N/O	
9	1	3028.0554	Schütz AEG LS 15K00	Contacteur AEG LS 15K00	K4
10	1	3102.1000	Wechselspannungskondensator 1,5 µF,250V	Capacitor 1,5 µF,250V AC	C1
11	1	3028.0554	Schütz AEG LS 15K00	Contacteur AEG LS 15K00	K1
12	1	3014.0326	Sicherheitstemperaturbegrenzer 360°C	Safety temperature limiter 360°C	F4
13	1	3014.0402	Überstromauslöser einpolig f. Motorschutz	Current limiter for motor protection	F3
14	1	3014.0300	Trockengeherschutz 135°C	Dry up protector 135°C	F5



**Elektromontageplatte / Electrical Installation**

 Spannung / Voltage: **3 N AC 400V 50Hz**

 Baugruppe / Group: **2** Ausgabe / Edition: **2.1.1**

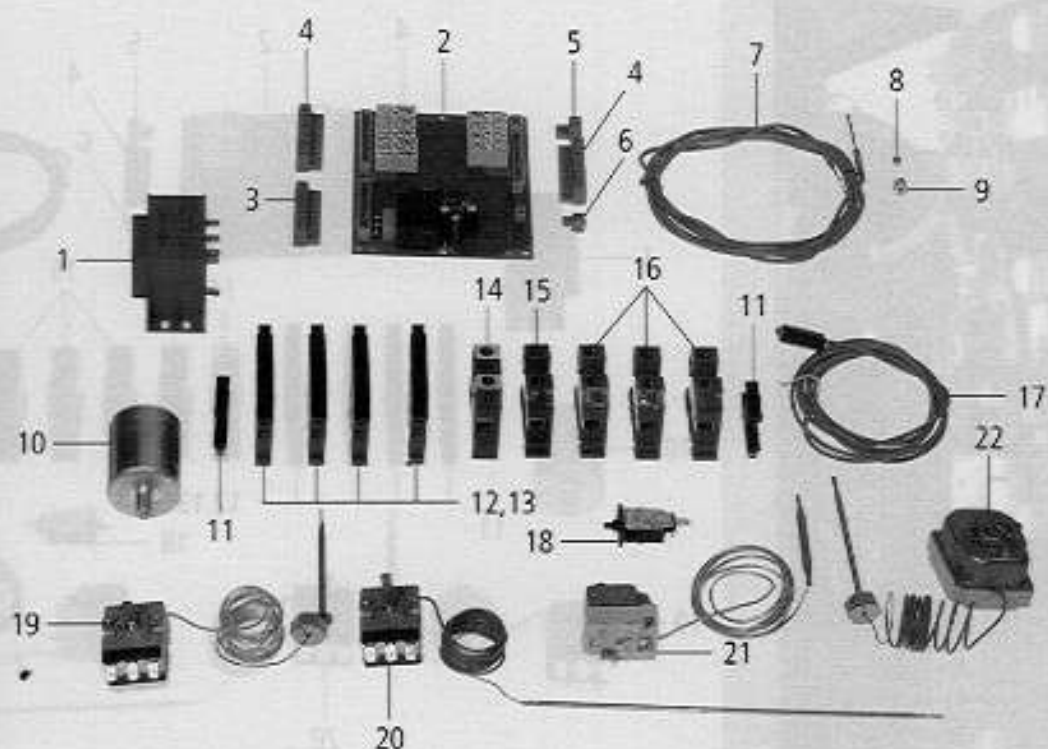
 Gültig ab Seriennummer / Applicable from serial. no.: **E12DA97061001**

Pos.	St.	Ersatzteil Nr.	Bezeichnung	Description	Bez. Sign.
Pos.	Pcs.	Spare part no.			
1	1	3037.0205	Halogentrafo 10VA	Halogen transformer 10VA	T1
2	1	3040.3100	Steuerelektronik	Control PCB	A1
3	1	3040.0197	Steckerleiste BL 10	Multipoint connector BL 10	
4	2	3040.0198	Steckerleiste BL 11	Multipoint connector BL 11	
5	1	3040.0260	Steckerleiste 2polig, 5.08	Multipoint connector 2polig,5.08	
6	1	3040.0259	Steckerleiste 2polig 3.81	Multipoint connector 2polig,3.81	
7	1	3014.0161	Mantelthermoelement	Sheath thermo element	B1
8	1	3014.0162	Dichtkegel für Thermoelement	Sealing cone for thermo element	
9	1	3014.0163	Stopfbuchsnippel für Thermoelement	Gasket sleeve with nipple	
10	1	3001.0454	Entstörfilter	Electronic noise filter	Z1
11	1	4001.1203	Endklammer für Tragschiene	End plate for supporting rail	
12	4	4001.1283	Sicherungsklemme 4mm <sup>2</sup>	Fuse holder terminal block 4mm <sup>2</sup>	F1,F6
13	1	4001.0224	Sicherung 6.35x32mm, 6.3A träge	Fuse 6.35x32mm, 6.3A slow	F1
13	3	4001.0225	Sicherung 6.35x32mm, 10A	Fuse 6.35x32mm, 10A	F6
14	1	4001.1233	Reihenklemme 35mm <sup>2</sup> gelb/grün	Earth terminal 16mm <sup>2</sup> yellow/green	
15	1	4001.1252	Reihenklemme 35mm <sup>2</sup> blau	Terminal 35mm <sup>2</sup> blue	
16	3	4001.1206	Reihenklemme 35mm <sup>2</sup> grau	Terminal 35mm <sup>2</sup> grey	
17	1	3016.1415	Türkontaktschalter	Door contact switch	S3
18	1	3014.0402	Überstromauslöser 1polig Motorschutz	Motor protector	F3
19	1	3014.0166	Thermostat Heißluft/ Gerät zu heiß	Thermostat hot air/ unit too hot	P2
20	1	3014.0312	Thermostat Ablöschung	Thermostat for quenching	P4
21	1	3014.0300	Trockengehschutz 135°C	Dry up protector 135°C	F5
22	1	3014.0326	Sicherheitstemperaturbegrenzer 360°C	Safety temperature limiter 360°C	F4

**Handbrause (Option) / Hand shower (option)**

 Spannung / Voltage: **3 N AC 400V 50Hz**

 Baugruppe / Group: **11** Ausgabe / Edition: **11.1.1**

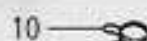
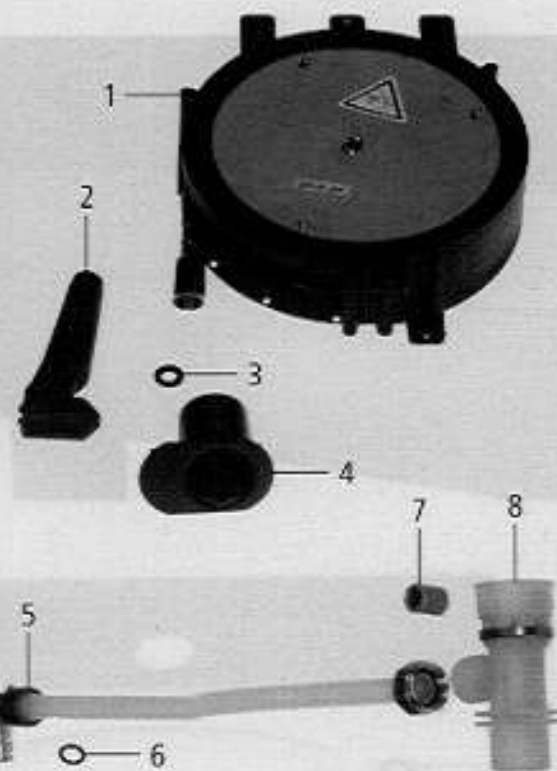
 Gültig ab Seriennummer / Applicable from serial. no.: **E12DA97061001**

Pos.	St.	Ersatzteil Nr.	Bezeichnung	Description	Bez. Sign.
Pos.	Pcs.	Spare part no.			
1	1	8655.2021	Schlauchroller	Handshower roll guide	
2	1	2060.1000	Handbrause	Hand shower	
3	1	5012.0539	Dichtung für Verschraubung G 1/2"	Gasket for G1/2" threaded joint	
4	1	2060.1210	Tulpe für Handbrause	Tulip for handshower	
-	4	1107.0103	Schnellbefestiger d3mm	Quick fastener d3mm	
5	1	2062.0328	Anschlußrohr Schlauchroller	Connection pipe hand shower	
6	2	2060.0228	O-Ring für Brauseschlauch	O-ring for shower hose	
7	1	2069.0105	Rückschlagventil DN8	Non return valve DN8	
8	1	8464.1300	T-Stück Wasseranschluss Handbrause	T-water connection handshower	
9	1	8455.1317	Gerätetropfwanne	Drip collector	
10	2	2066.0525	Schlauchklemme 22,1mm	Hose clamp 22,1mm	
11	1	2110.1002	Silikonschlauch d15x3	Silicone hose d15x3	

**Heißluftheizung / Hot air heating**

Spannung / Voltage: **3 N AC 400V 50Hz**

Baugruppe / Group: **5** Ausgabe / Edition: **5.1.1**

Gültig ab Seriennummer / Applicable from serial. no.: **E12DA97061001**

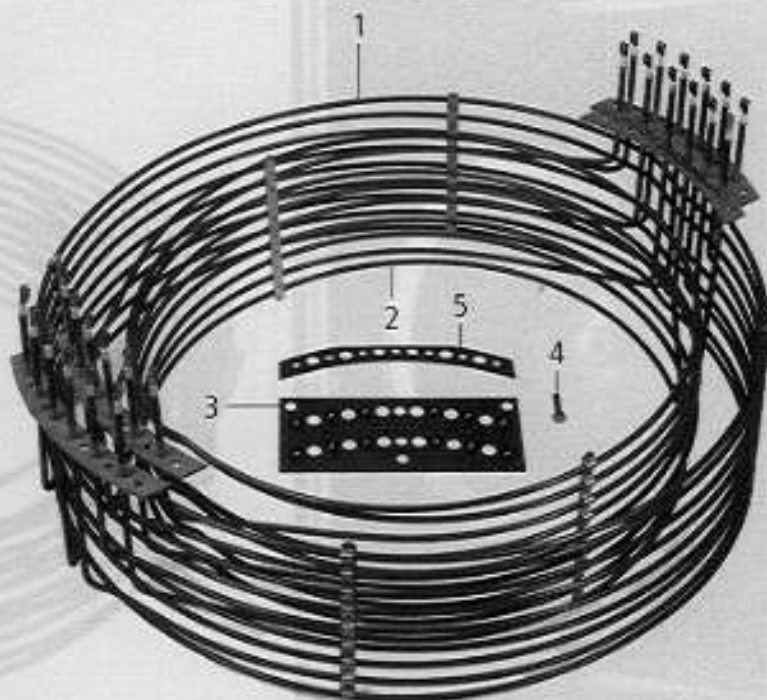
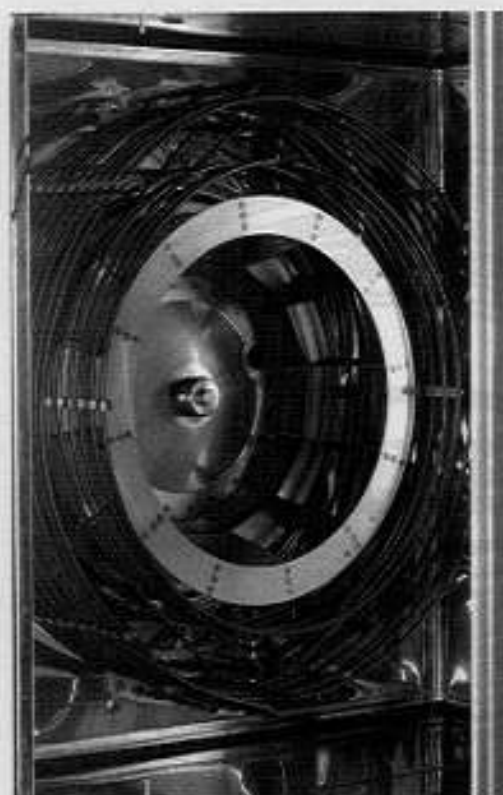

Pos.	St.	Ersatzteil Nr.	Bezeichnung	Description	Bez.
Pos.	Pcs.	Spare part no.			Sign.
1	1	3200.1003	Heizregister außen 230V	Outer heating assembly 230V	
2	1	3200.1002	Heizregister innen 230V	Inner heating assembly 230V	
3	2	2150.1252	Doppelflansch Aussenseite für Heizregist	External flange for Hot Air heater type	
4	12	1006.0766	Sechskantschraube M 6x25, HL Register	Hexagonal screw M6x25, hot Air heater	
5	12	1306.0222	Unterlegscheibe 6.4x15x1.5	Washer A6.4x15x1.5	
6	4	5110.1009	Dichtring f. Heizregister	Seal ring for heating assembly	



**Garraum / Interior cabinet**

Spannung / Voltage: **3 N AC 400V 50Hz**

Baugruppe / Group: **7** Ausgabe / Edition: **7.1.1**

Gültig ab Seriennummer / Applicable from serial. no.: **E12DA97061001**

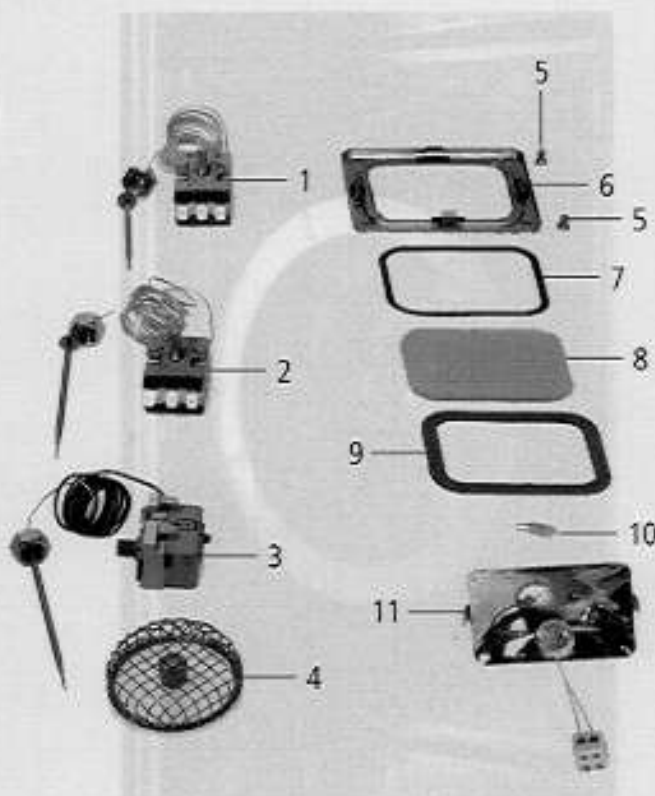

Pos.	St.	Ersatzteil Nr.	Bezeichnung	Description	Bez.
Pos.	Pcs.	Spare part no.			Sign.
-	1	8516.1313	Luftleitblech	Air baffle	
1	1	3014.0166	Thermostat Heißluft/ Gerät zu heiß	Thermostat hot air/ unit too hot	P1
2	1	3014.0166	Thermostat Heißluft/ Gerät zu heiß	Thermostat hot air/ unit too hot	P2
3	1	3014.0326	Sicherheitstemperaturbegrenzer 360°C	Safety temperature limiter 360°C	F4
4	1	2005.0302	Ablaufsieb	Outlet sieve	
5	4	1008.0753	Sechskantschraube M 5x8	Hexagonal screw M5x8	
6	1	8514.1017	Andrückrahmen f. Garraumbeleuchtung	Press down frame for interior lighting	
7	1	5110.1022	Dichtungsrahmen außen	External gasket frame	
8	1	5201.1000	Glas f. Garraumbeleuchtung	Glass for interior lamp	
9	1	5110.1023	Dichtungsrahmen innen	Internal gasket frame	
10	1	3024.0201	Halogengarraumlampe 10 W/12V/300°	Halogen bulb 10 W/12V/300°	
11	1	8514.1018	Reflektor kpl. f. Garraumbeleuchtung	Reflector unit for interior lighting	

## Sonstiges / Miscellaneous

Baugruppe / Group: 12 Ausgabe / Edition: 12.1.1

Gültig ab Seriennummer / Applicable from serial. no.: E12DA97061001

Pos.	Ersatzteilnr.:	Bezeichnung	Description
Pos.	Spare part no.		
1	1003.2260	Linsensenk-Blechschaube HC4,2x16	Raised countersunk head - self-tapping screw HC4,2x16
2	1004.2160	Sechskant Blechschaube B4,2x16	Hex head tapping screw B4, 2x16
3	1104.0821	Blechmutter B3,9	Climp B3,9
4	1107.0100	Schnellbefestiger d4,0 mm	Quick fastener d4.0 mm
5	1107.0101	Schnellbefestiger d5,0mm	Quick fastener d5,0mm
6	1107.0102	Schnellbefestiger d12mm	Quick fastener d12mm
7	1107.0103	Schnellbefestiger d3mm	Quick fastener d3mm
8	1311.2260	Schraubenrosette 5x12,5	Rosette 5x12,5
9	1603.0165	Blindniete 3,2x9,5	Blind rivet 3.2x9.5
10	1901.0042	Blechklammer für Außenmantel	Clamp for exterior cabinet
11	1901.0044	Blechklammer für Deckel bis 05/95	Clamp for cover up to 05/95
12	2001.0042	Loctite Schraubensicherung 10ml	Screw locking, heat resistant 10ml
13	2005.0603	Lenkrolle d/125 mit Feststeller	Castor d/125 with stopper
14	2005.0604	Lenkrolle d/125 ohne Feststeller	Castor d/125 without stopper
15	2039.0111	Metall-Einsteckfuß 40x40	Foot adjustable metal, 40 x 40
16	2039.0120	Fußoberteil 85mm	Upper part of pedestal 85mm
17	2039.0121	Fußunterteil	Lower part of pedestal
18	3016.1409	Magnet rund Tischgeräte	Magnet round table models
19	4002.0100	Flachsteckhülse 2,5x6,3	Cable shoes 2,5x6,3
20	4004.0100	Aderendhülse 1,0mm <sup>2</sup>	Wire end sleeve 1,0mm <sup>2</sup>
21	4004.0101	Aderendhülse 1,5mm <sup>2</sup>	Wire end sleeve 1,5mm <sup>2</sup>
22	4004.0102	Aderendhülse 2,5mm <sup>2</sup>	Wire end sleeve 2,5mm <sup>2</sup>
23	4004.0103	Aderendhülse 4mm <sup>2</sup>	Wire end sleeve 4mm <sup>2</sup>
24	4004.0104	Aderendhülse 6mm <sup>2</sup>	Wire end sleeve 6mm <sup>2</sup>
25	4004.0105	Aderendhülse 10mm <sup>2</sup>	Wire end sleeve 10mm <sup>2</sup>
26	4004.0106	Aderendhülse 16mm <sup>2</sup>	Wire end sleeve 16mm <sup>2</sup>
27	4004.0114	Aderendhülse 0,75mm <sup>2</sup>	Wire end sleeve 0,75mm <sup>2</sup>
28	4005.0101	Kabelbinder 145mm lang	Cable strap 145mm long
29	4005.0102	Kabelbinder 100mm lang	Cable strap 100mm long
30	4007.0305	Kabelverschraubung PG 21	Screw-type conduit fitting PG 21
31	4007.0306	Reduzierstück PG 29/21	Reducing socket PG 29/21
32	4007.0405	Kabelverschraubung PG 16	Screw-type conduit fitting PG 16
33	4007.0406	Reduzierstück PG 29/16	Reducing socket PG 29/16
34	4007.0521	Sechskantmutter für PG 13,5	Hex screw for PG 13,5
35	4007.0526	Sechskantmutter für PG 21	Hex screw for PG 21
36	4007.0604	Kabelverschraubung PG 42 mit Zugentlast.	Cable connection PG 42, strain relief
37	4007.0605	Sechskantmutter PG42	Lock nut cable connection PG 42
38	4007.0606	Kabelverschraubung PG 36	Screw-type conduit fitting PG 36
39	4007.0607	Sechskantmutter für PG 36	Hex screw for PG 36
40	4007.0614	Stopfen PG 13,5	Plug PG 13,5
51	4007.0615	Stopfen PG 21	Plug PG 21
52	4007.0621	Durchführungsstülpe d 36mm	Lead-in grommet d 36 mm
53	5003.0300	Isolierung Dampfgenerator 1250x1250mm	Insulation steam generator 1250x1250mm
54	5006.0200	Tube Silikon E41	Silicone (tube) E41
55	5006.0500	Kleber Isolierung Dampfgenerator 310ml	Adhesive insulation steam generator 310ml
56	6004.0100	Handdruck Sprühpistole	Spray-pistol
57	6004.0101	Verlängerung Handdruck Sprühpistole	Lengthening piece for spray-pistol
58	6004.0102	Dichtung Handdruck Sprühpistole	Gasket for spray-pistol
59	6004.0203	Entkalker-Fußpumpe	Descaler foot pump
60	6006.0101	RATIONAL Spezialreiniger	RATIONAL special cleaning agent
61	6006.0110	RATIONAL Entkalker	RATIONAL descaler
62	9003.0202	Unimoly plus, 180 °C	Unimoly plus, 180 °C
63	9006.0850	Metallwaschcreme	Stainless steel cleaning paste



**Motor und Lüfterrad / Motor and fan wheel**

Spannung / Voltage: **3 N AC 400V 50Hz**

Baugruppe / Group: **6** Ausgabe / Edition: **6.1.1**

Gültig ab Seriennummer / Applicable from serial. no.: **E12DA97061001**

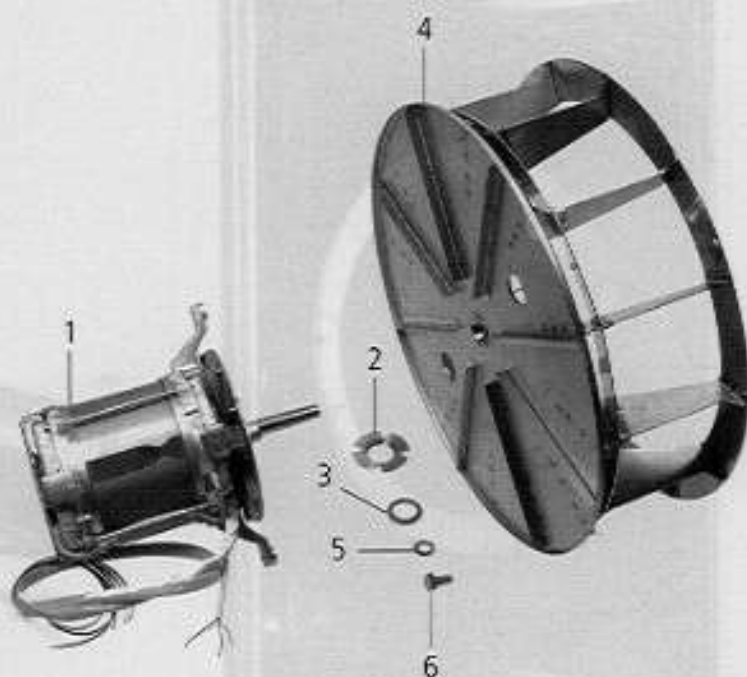

Pos.	St.	Ersatzteil Nr.	Bezeichnung	Description	Bez.
Pos.	Pcs.	Spare part no.			Sign.
1	1	3100.1023	Lüftermotor	Fan motor	M1
-	4	1108.0260	Sechskantmutter M 8	Hexagonal nut M8	
-	4	1208.0260	Federring B8	Spring washer B8	
2	1	2016.0876	Dichtungsflansch für Motorwelle	Gasket flange for engine shaft	
3	1	5001.0207	Motorwellendichtung	Motor shaft gasket type	
-	4	1106.0220	Sechskantmutter M6 flach	Hexagonal nut M6 flat	
-	4	1306.0120	Unterlegscheibe A6,4	Washer A6,4	
4	1	2012.0508	Lüfterrad	Fan wheel	
5	1	1328.0103	Sperrkantscheibe A16,4	Safety washer A16,4	
6	1	1016.0701	Sechskantschraube M 16x25	Hexagonal screw M16x25	

**Sicherheitsventil / Safety valve**

 Spannung / Voltage: **3 N AC 400V 50Hz**

 Baugruppe / Group: **9** Ausgabe / Edition: **9.1.1**

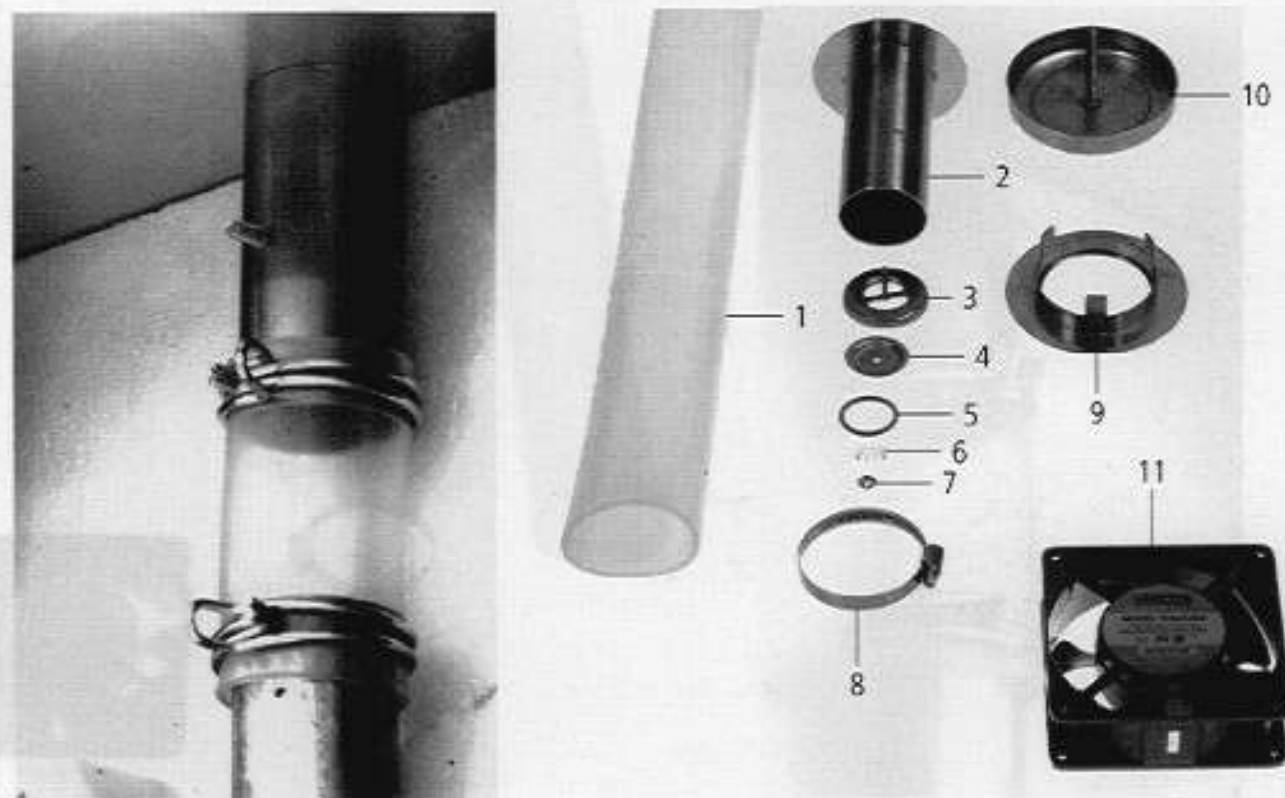
 Gültig ab Seriennummer / Applicable from serial. no.: **E12DA97061001**

Pos.	St.	Ersatzteil Nr.	Bezeichnung	Description	Bez.
Pos.	Pcs.	Spare part no.			Sign.
1	1	2112.1301	Silikonschlauch d50x3x100	Silicone hose d50x3x100	
2	1	8450.1305	Rohr für Sicherheitsventil	Mounting pipe for safety valve	
3	1	2064.1302	Teller für Sicherheitsventil	Base for safety valve	
4	1	2064.1304	Deckel für Sicherheitsventil	Cover for safety valve	
5	1	5012.0546	O-Ring d 17,0x2,0mm	O-ring d 17,0x2,0mm	
6	1	2001.0117	Druckfeder für Sicherheitsventil	Compression spring for safety valve	
7	1	1107.0103	Schnellbefestiger d3mm	Quick fastener d3mm	
8	2	2066.0504	Schlauchschelle 40-60mm	Hose clamp 40-60mm	
9	1	2812.1304	Abstandshalter für Glocke	Spacer for vent cover	
10	1	8455.1209	Glocke	Vent cover	
11	1	3101.1008	Kühllüfter	Cooling motor	M3

**Dampfgenerator / Steam generator**

Spannung / Voltage: **3 N AC 400V 50Hz**

Baugruppe / Group: **4** Ausgabe / Edition: **4.1.1**

Gültig ab Seriennummer / Applicable from serial. no.: **E12DA97061001**

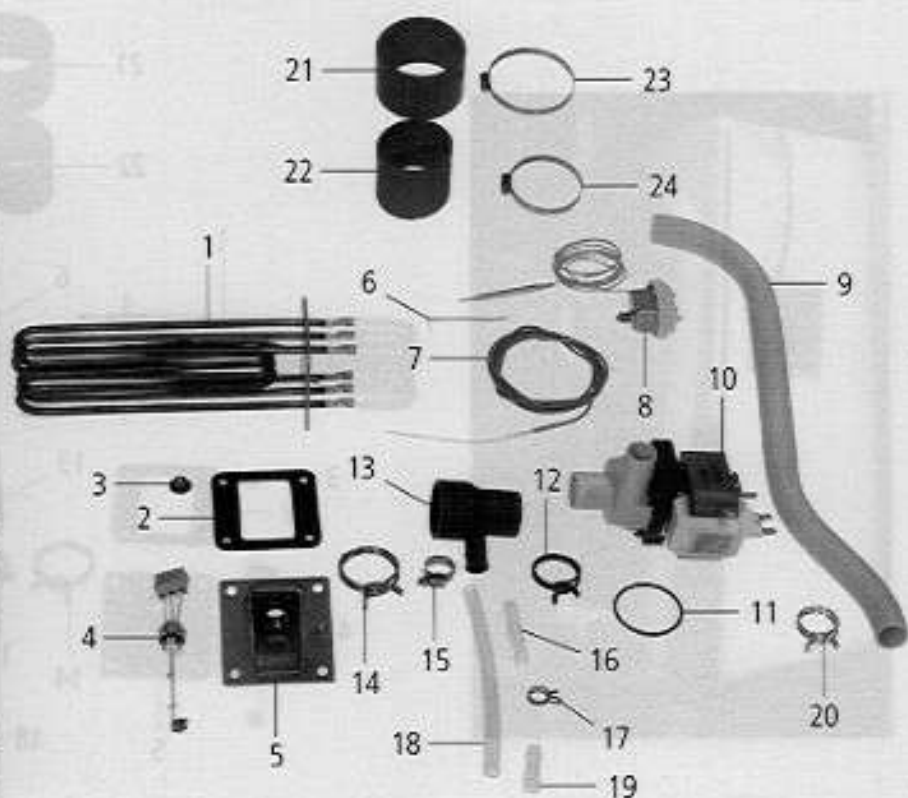

Pos.	St.	Ersatzteil Nr.	Bezeichnung	Description	Bez. Sign.
Pos.	Pcs.	Spare part no.			Sign.
-	-	2067.0050	Silikonschlauch 1m	Silicone hose 1m	
1	3	3201.1000	Tauchheizkörper 3x3 kw 230V	Heating element 3x3 kw 230V	
2	4	5110.1003	Dichtung f. Tauchheizkörper	Gasket for heating element	
3	16	1106.0803	Sechskant-Combinutter M6 verzinkt	Hex combi nut M6 galv	
4	1	3002.0402	Füllstandselektrode 90mm	Filling level electrode 90mm	S4
5	1	2920.1300	Einsatz Niveauelektrode	Level elektrode insert	
6	1	2740.1040	Klemmblech Dampfgenerator	Clamping plate for steam generator	
7	1	3014.0165	Thermoelement Dampfgenerator	Thermo element steam generator	B2
8	1	3014.0300	Trockengehschutz 135°C	Dry up protector 135°C	F5
9	1	2112.1304	Entleerschlauch	Emptying hose	
10	1	3002.1000	Entleerungspumpe 200-240V 50/60Hz	Emptying pump 200-240V 50/60Hz	M2
11	1	5012.0560	O-Ring Dichtung Entleerungspumpe	O-Ring gasket emptying pump	
12	1	2066.0519	Schlauchklemme 35,6mm	Hose clamp 35,6mm	
13	1	2118.1000	Pumpenanschlußstutzen	Pump connection spout	
14	1	2066.0526	Schlauchklemme 46mm	Hose clamp 46mm	
15	1	2066.0530	Schlauchklemme 16,4mm	Hose clamp 16,4mm	
16	1	2062.0331	Verbindungsteil GS 10	Connecting piece GS 10	
17	1	2066.0527	Schlauchklemme 14mm	Hose clamp 14mm	
18	1	2110.1008	Silikonschlauch DG-Entleerung	Drain hose steam generator	
19	1	2120.1259	Stopfen 10mm Entleerschlauch DG	Stop plug 10mm drain hose steam generat.	
20	2	2066.0518	Schlauchklemme 30mm	Hose clamp 30mm	
21	1	2112.1307	Dampfschlauch	Steam hose	
22	1	2112.1006	Dampfschlauch 50x7mm	Steam hose 50x7mm	
23	2	2066.0516	Schlauchschele 60-80mm	Hose clamp 60-80mm	
24	2	2066.0300	Schlauchschele 50-70mm	Hose clamp 50-70mm	



**Wasseranschluß / Water supply**

 Spannung / Voltage: **3 N AC 400V 50Hz**

 Baugruppe / Group: **10** Ausgabe / Edition: **10.1.1**

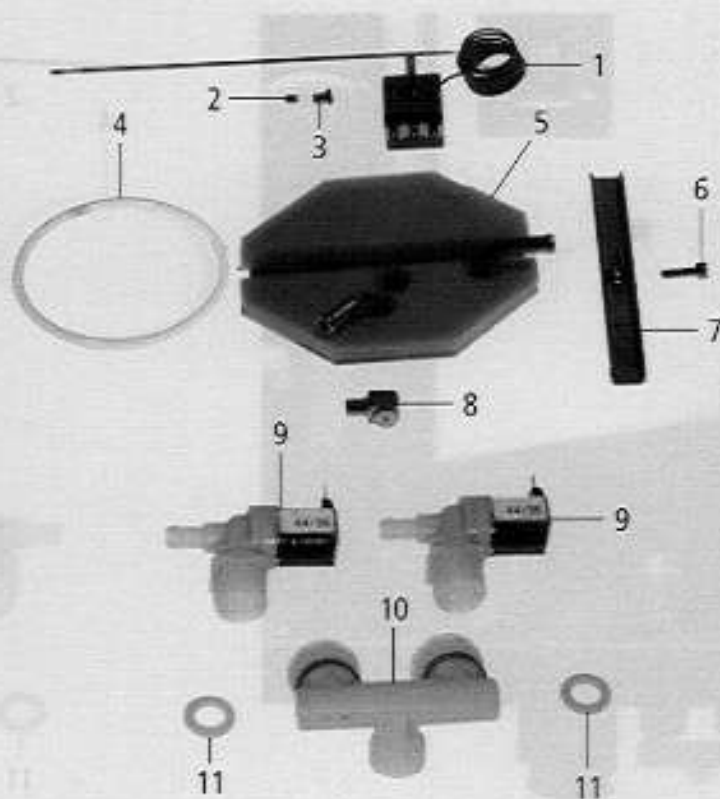
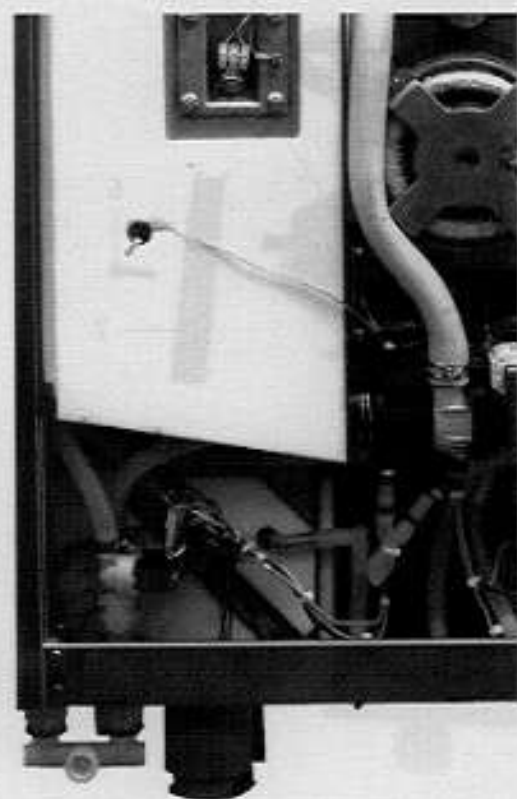
 Gültig ab Seriennummer / Applicable from serial. no.: **E12DA97061001**

Pos.	St.	Ersatzteil Nr.	Bezeichnung	Description	Bez. Sign.
Pos.	Pcs.	Spare part no.			
-	-	2067.0050	Silikon Schlauch 1m	Silicone hose 1m	
-	4	2066.0205	Schlauchschnalle 12-18mm	Hose clamp 12-18mm	
1	1	3014.0312	Thermostat Ablöschung	Thermostat for quenching	P4
2	1	5110.1307	Dichtung für Thermostat	Gasket for thermostat	
3	1	3014.0163	Stopfbuchsnippel für Thermoelement	Gasket sleeve with nipple	
4	1	5012.0566	O-Ring Dichtung Ablöschkasten	O-Ring gasket quenching chamber	
5	1	8666.1318	Flansch Ablöschkasten	Flange quenching chamber	
6	1	1008.0752	Sechskantschraube M5x10	Hexagonal screw M5x10	
7	1	2715.1320	Spannbügel für Revisionsdeckel Ablöschkasten	Cross bar for cover quenching box	
8	1	2016.0935	Ablöschdüse 2,3 l/min	Quenching nozzle 2.3 l/min.	
9	2	3002.0331	Einfachmagnetventil kpl. 220-240V 50Hz	Single solenoid valve unit 220-240V 50Hz	Y1,Y2
10	1	8664.1301	Brückenfitting 3/4" Wasseranschluss	Water connection fitting 3/4"	
11	2	5110.1024	Dichtung für Verschraubung G 3/4"	Gasket for G3/4" threaded joint	